

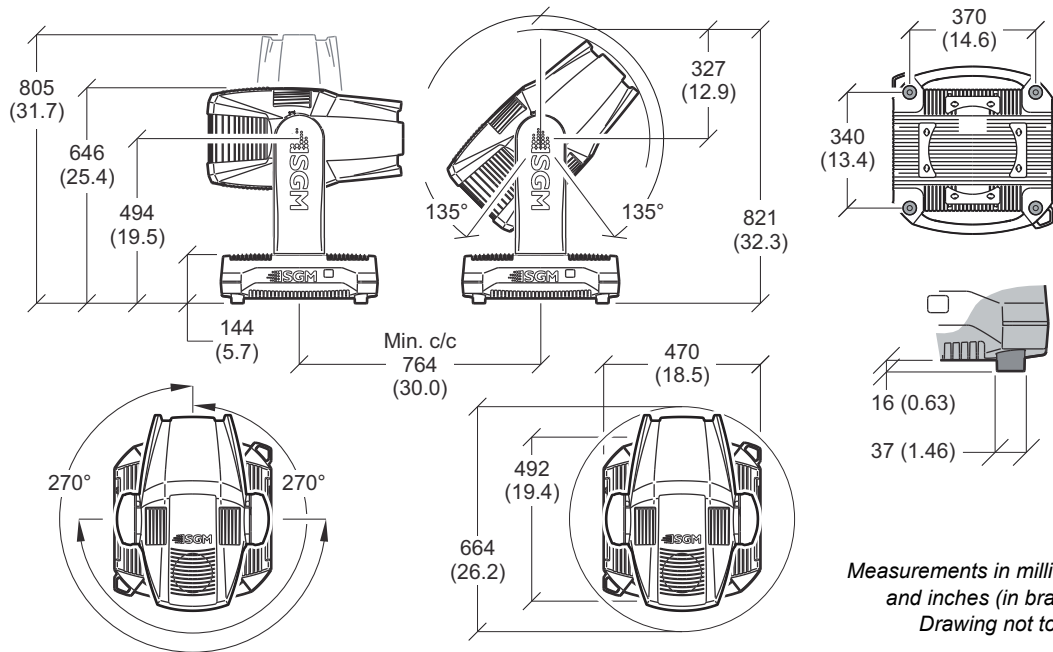

**G-PROFILE
MOVING HEAD**



Dimensions



G-PROFILE USER MANUAL

© 2015 SGM Light®. Information subject to change without notice. SGM Light and all affiliated companies disclaim liability for any injury, damage, direct or indirect loss, consequential or economic loss or any other loss occasioned by the use of, inability to use or reliance on the information contained in this manual.

The SGM logo, the SGM Light name and all other trademarks in this document pertaining to services or products by SGM Light or its affiliates and subsidiaries are trademarks owned or licensed by SGM Light or its affiliates or subsidiaries.

The original edition of this document is in English. All other language editions are translations of the original edition.

This edition applies to firmware version 1.59 or later.

Rev. D

Contents

Dimensions	2
Safety information	7
Overview	10
Unpacking	11
<i>Transportation</i>	11
Installation / Rigging	12
Connecting AC power	14
Control panel operations	15
<i>Using the control panel</i>	15
<i>DMX start address</i>	15
<i>Selecting module (G-Profile or G-Spot)</i>	15
<i>Configuring the fixture using an Android device via RFID</i>	16
<i>SGM Tool App for Android</i>	16
<i>Getting fixture information using Android and RFID</i>	16
<i>Setting a DMX address and mode using Android and RFID</i>	16

Using stand-alone operation	17
<i>Manual control / Internal sequence editor</i>	17
<i>Using the editor</i>	18
<i>Editor</i>	18
Connecting to a DMX control device	19
Configuring the device for DMX control	20
<i>About DMX</i>	20
<i>Setting the DMX address</i>	20
LED refresh rate (Frequency)	21
<i>About LED refresh rate</i>	21
<i>Setting the LED refresh rate (Frequency) via DMX</i>	21
Control panel menus	22
Gobo replacement	34
<i>Identification of gobo wheel</i>	34
<i>Replacing rotating gobo</i>	35
<i>How to replace a gobo in a gobo holder</i>	36
Maintenance	37
<i>Upgrading the firmware</i>	37
<i>Cleaning</i>	37

DMX protocols	38
<i>Standard Mode</i>	38
<i>Extended Mode</i>	51
<i>Full Color Calibration and Color Temperature Correction</i>	64
Effects	65
<i>Four individually controllable framing blades</i>	65
<i>Independent rotating gobo wheel</i>	65
<i>Combination of framing techniques and rotating gobos</i>	65
<i>Effect wheel</i>	66
<i>High-precision pan and tilt</i>	66
<i>Ultra high-speed strobe effect</i>	66
<i>Prism</i>	66
<i>Frost</i>	66
Fixtures and accessories	67
<i>Included items</i>	67
<i>Ordering information</i>	67
User's notes	69

Safety information



WARNING! Read the safety precautions in this section before unpacking, installing, powering or operating this product.

The G-Profile is intended for professional use only. It is not suitable for household use. **Impropre a l'usage domestique.**

Review the following safety precautions carefully before installing or operating the fixture.

This product must be installed in accordance with the applicable installation code by a person familiar with the construction and operation of the product and the hazards involved. **Ce produit doit être installé selon le code d'installation pertinent, par une personne qui connaît bien le produit et son fonctionnement ainsi que les risques inhérent.**

Preventing electric shock



WARNING! Risk of electric shock.

- Always power off/unplug the fixture before removing covers or dismantling product.
- Ensure that the mains power is off when wiring the fixture to the AC mains supply.
- Ensure that the fixture is electrically connected to earth (ground).
- Do not apply power if the fixture is in any way damaged.
- Do not immerse the fixture in water or liquid.

Preventing burns and fire



WARNING! Take measures to prevent burns and fire.

- Install in a location that prevents accidental contact with the fixture.
- Install only in a well-ventilated space.
- Install at least 0.3 m (12 in.) away from objects to be illuminated.
- Install only in accordance with applicable building codes.
- Ensure a minimum clearance of 0.1 m (4 in.) around the cooling fans.
- Do not paint, cover or modify the fixture.
- Keep all flammable materials away from the fixture.
- Allow the fixture to cool for 15 minutes after operation, before touching it.

CAUTION: Exterior surface temperature after 5 min. operation = 55° C (131° F). Steady state = 65° C (149° F)

Avoid personal injury



WARNING! Take measures to prevent personal injury.

- Do not look directly at the light source from close range.
- Take precautions to prevent injury when working at height.
- Ensure that the fixture is always securely fastened with suitable hardware.
- For elevated installations, secure the fixture with suitable safety cables, and always comply with relevant load dimensioning, safety standards and requirements.

Overview

The SGM G-Profile model is a framing version of the G-Spot Moving Head. The G-Profile is a maintenance free, multi-environmental fixture with an IP-rating of 65. It has a powerful LED light source, and a virtually unlimited color palette, four individually controllable framing blades, and can easily be controlled by wired and wireless DMX. The fixture also offers RFID and NFC, low power consumption and an expected lifetime of the multiple LED's of 50,000 hours*.

- A : Pan lock
- B : Tilt lock
- C : Base handle
- D : Head fan grill (one of two shown)
- E : Display panel
- F : Safety wire attachment point
- G : Fuse
- H : DMX in
- I : DMX out
- J : Power in
- K : Power cord

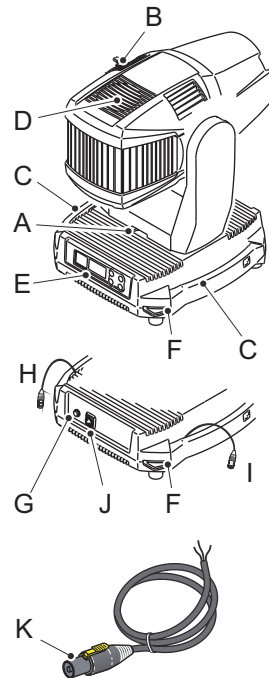

* At 70% of luminous output under the manufacturer's test conditions.

Unpacking

Unpack the fixture and inspect it to ensure that it has not been damaged in transport.

The G-Profile is supplied with:

- User manual.
- One Neutrik TRUE1 power input connector, 2 m (78 in.)
- Two Omega brackets with 1/4-turn fasteners.

The fixture is designed for use in wet locations and is IP65-rated. When selecting a location for the fixture, ensure that:

- it is situated away from public thoroughfares and protected from contact with people.
- it has adequate ventilation.

Transportation

Always use the supplied packaging for transportation and storage.

Release the pan/tilt locks when transporting the fixture. Leaving the pan/tilt locks applied may cause damage to the fixture.

Installation / Rigging



WARNING! Always secure elevated fixtures with a safety cable.

The G-Profile may be installed in any orientation.

Always use two Omega brackets to rig the fixture. Lock each bracket with both 1/4-turn fasteners. The fasteners are locked only when turned fully clockwise.

Always fasten safety cables between the load-bearing support structure and the attachment points on the fixture. The safety cables must be able to bear at least 10 times the weight of the fixture.

CAUTION:

- Always use 2 safety wires.
- Min. safety wire gauge = 5 mm.
- Max. safety wire length (free fall) = 30 cm (11 in.)
- Make sure the slack of the safety wire is at a minimum.
- Never use the carrying handles for secondary attachment.

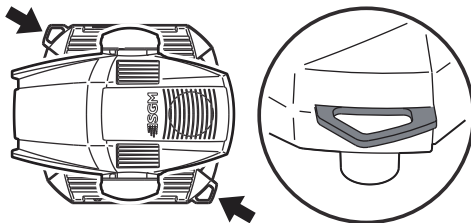
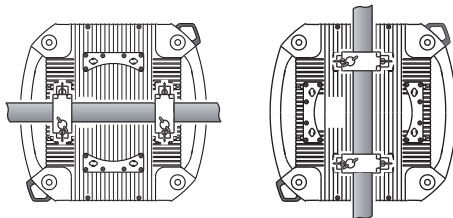

Start the rigging process by blocking the work area below, and make sure the work is performed from a stable platform.

- 1 Check that the clamps are undamaged and can bear at least 10 times the weight of the fixture. Check that the structure can bear at least 10 times the weight for all installed fixtures, clamps, cables etc.
- 2 Bolt each clamp securely to an Omega bracket with an M12 / 1/2" bolt (min. grade 8.8) and lock nut.
- 3 Align an Omega bracket with two 1/4-turns in the base. Insert the fasteners into the base and turn both levers a full 1/4-turn clockwise to lock. Install the second Omega bracket.
- 4 Working from a stable platform, hang the fixture on a truss, or other structure. Note the position of the base. The front of the base is to the right, when looking at the display panel, and when the fixture is sitting on the base. Tighten the clamps.
- 5 Install two safety wires that each can bear at least 10 times the weight of the unit. The attachment points are designed to fit a carabiner.
- 6 Check that the pan/tilt locks are released (A and B). Verify that there are no combustible materials or surfaces to be illuminated within 0.3 m (12 in.) of the fixture.
- 7 Check that there is no possibility of head or yoke colliding with other fixtures.

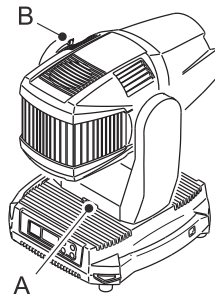
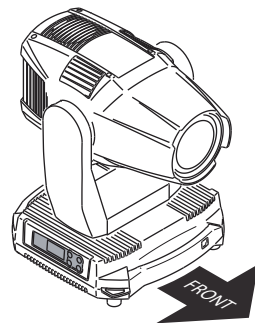

Connecting AC power



The G-Profile can operate on any 200-240V, 50/60 Hz mains power supply.

Connect the fixture to power using a cable with a Neutrik powerCON TRUE1 connector (supplied with the fixture). Connect both DMX in and DMX out cables in order to maintain the fixture IP65.

The fixture must be grounded/earthed and be able to be isolated from AC power. The AC power supply must incorporate a fuse or circuit breaker for fault protection.

- Connect the black wire to live
- Connect the white wire to neutral
- Connect the green wire to ground (earth)

After connecting the G-Profile to power, run the on-board test, using the “Test→LED Test” menu, to ensure that the fixture is functioning correctly. See “Control panel menus” on page 22.

Wire	Color	Symbol	Conductor
	Black	L	live
	White	N	neutral
	Green	⏏ or ⏚	ground (earth)

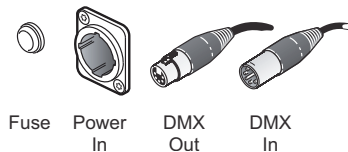
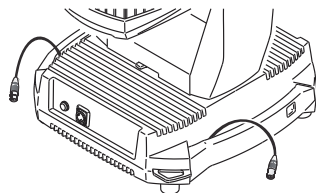
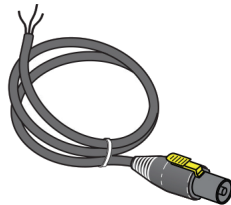

Control panel operations

You can configure individual fixture settings, read out data and view error messages in the graphic display. When the fixture is powered on, it boots and resets, then displays the DMX start address and any status messages.

Using the control panel

- Click the arrow buttons to scroll up and down menus.
- Click the OK button to enter a menu or make a selection.
- Press the ESC button to step backwards through the menus.

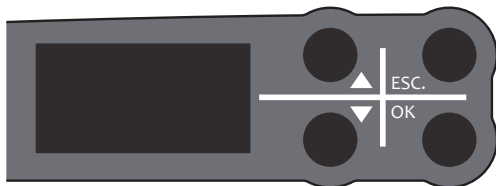

DMX start address

The DMX start address is the first channel used to receive instructions from the controller. For independent control, each fixture must be assigned its own control channels. If you give two fixtures the same address, they will behave identically. Address sharing can be useful for diagnostic purposes and symmetrical control.

Select DMX address using the arrow buttons.

Selecting module (G-Profile or G-Spot)

If you replace the fixture's module in order to switch from a G-Profile to a G-Spot or vice-versa, you need to change the fixture's software settings.

In the Control Menu, go to 'Settings→Service Menu→Fixture Type' and select the fixture you are currently using.

NOTE: To access "Service Menu→Fixture Type", you need to type in the value '0110' under 'Settings→Service Pin". See "Control panel menus" on page 22 for more details.

Configuring the fixture using an Android device via RFID

The G-Profile can also be configured wirelessly, via RFID, using the SGM Tool app installed on an Android device that has NFC support, App available in the Google™ Play Store (ISO 15693 and ISO 18000-3 mode 1 compatible, operating on 13.56 MHz \pm 7k Hz carrier frequency).

SGM Tool App for Android

The SGM tool application features the ability to, readout product information, setting DMX address, setting DMX mode. All functions can be accessed, changed and stored without having the fixture powered on.

Overview by tabs:

[INFORMATION] Product name, DMX address, DMX mode, Running hours, Serial number

[SET DMX ADDRESS] DMX address, Fixture size (DMX footprint), Fixture type, Fixture mode, Auto increase

First make sure the RFID/NFC is enabled on your device, then open the application and you are ready to scan a fixture.

Getting fixture information using Android and RFID

1. Scan fixture.
2. Informations about the fixture is shown including:
 - Product name/type.
 - DMX address and DMX mode.
 - Running hours and serial number.

Setting a DMX address and mode using Android and RFID

1. Scan fixture or press the menu button on the Android device and choose “Goto DMX addressing”.
2. Go to tab [SET DMX ADDRESS]
3. Select Fixture type, Mode and whichever you want to Auto increase the address for the next fixture
4. When all settings is correct, transfer/store the settings to the fixture by holding the device close to the fixtures RFID, when the screen goes green and a sound is played, the settings is transferred and stored.

Using stand-alone operation

Stand-alone operation is where the fixture is not connected to a control device, but is preprogrammed with a series of up to 24 scenes, that play continuously in a loop. This program can be set to run by default whenever the fixture is started.

Manual control / Internal sequence editor

The editor offers the ability to adjust all DMX parameters of the fixture. Each scene has its own DMX settings. Each scene has a definable fade-in time, for the transition from the previous scene, and a wait (static) time, each with a fade time up to 4000 seconds and a wait time up to 4000 seconds.

The 24 scenes can be preset directly from the editor using the control panel.

The editor can also capture DMX values from a controller utilizing the 'Control-channel' (See "DMX protocols" on page 38) or capture live DMX values directly using the editor on the fixture.

To set a single static scene, set the fade time of scene 2 to 0.0 seconds, this will keep the fixture running scene 1.

To set a sequence of less than 24 scenes, set the fade time of the scene after the last scene to 0.0 seconds, this will keep the fixture looping scene 1 to the scene before the scene with 0.0 seconds fade time.

The copy/paste function offers the ability to create replicas of a previous created scene.

Locating the editor:

- Press OK to enter the menu.
- Navigate to "Manual" and press enter.

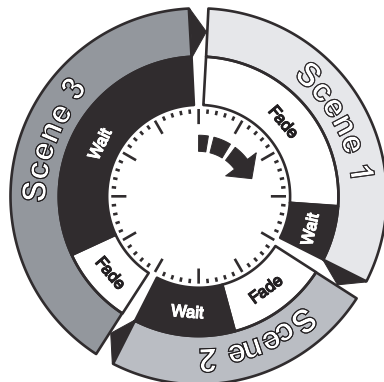

Using the editor

In the manual menu the following menus will be available:

- Editor
- Run Program
- Stop Program
- Run on power on
- Capture DMX

Editor

In the “Editor” menu you have the following options:

- Scene - Press OK and choose a scene (1 to 24) confirm with OK.
- Wait Time - Press OK and set the wait time (0 to 4000 seconds) confirm with OK.
- Fade Time - Press OK and set the fade time of the selected scene (0 to 4000 seconds) confirm with OK.
- Copy Scene - Press OK to copy the selected scene to the clipboard.
- Paste Scene - Press OK to paste copied scene from the clipboard to the selected scene.
- Clear Scene - Press OK to clear the selected scene and set the default settings.
- All the controllable features will be listed below “Clear Scene”.

To change a value of a feature:

- Select the feature to change.
- Press OK and change the value.
- Confirm with OK.

Channels operating in 8 bit mode will allow you to set a value from 0 to 255.

Channels operating in 16 bit mode will you allow to set a value from 0 to 65535.

Connecting to a DMX control device

The G-Profile is controllable using a DMX control device and it can be connected using either a DMX cable or via the fixture's built-in LumenRadio CRMX wireless receiver system.

If using a cabled DMX system, connect the DMX in cable (with male 5-pin XLR plug) and out cable (with female 5-pin XLR plug) to the DMX data link. Terminate the DMX out cable of the last fixture in the data link. For outdoor installations, use only IP-rated XLR connectors suitable for outdoor use.

Configuring the device for DMX control

About DMX

The G-Profile can be controlled using signals sent by a DMX controller on a number of channels (which varies depending on the DMX mode that has been set).

The first channel used to receive data from a DMX control device is known as the DMX start address. Each G-Profile must have a DMX start address set. For example, if a fixture has a DMX address of 10 and it is in 3-channel DMX mode, then it uses channels 10, 11, and 12. The following device in the DMX chain could then be set to a DMX address of 13. If two or more DMX devices of the same type have the same DMX address, then they will mimic each other's behavior. Incorrect settings will result in unpredictable responses to the lighting controller.

Setting the DMX address

The DMX address can be seen on the OLED display. To change the address setting, press the up and down arrows. When the desired address is displayed, press 'OK' to save the setting. For your convenience, the suggested DMX address of the next device is displayed to the right. Note that channel spacing is determined by the DMX mode.

See the "DMX protocols" on page 38 for specific DMX control values.

LED refresh rate (Frequency)

About LED refresh rate

When using LED lighting with cameras, flickering can occur due to incompatible frequency settings which means the LEDs and the cameras is not synchronised.

In order to avoid flickering and horizontal banding (rolling shutter) the refresh rate (frequency) can be adjusted in order to achieve flicker-free performance.

Setting the LED refresh rate (Frequency) via DMX

The G-Profile offers the ability to adjust the refresh rate (frequency) of the LEDs via DMX.

By utilizing the 'Control channel' (channel 31 in standard mode, channel 46 in extended mode).

See "DMX protocols" on page 38 for details.

The refresh rate can be set between 100,00 kHz and 1,41 kHz.

It is recommended to have the G-Profile configured to operate the default refresh rate by setting the 'Control channel' to 0 (0%) (factory default settings) by DMX whenever possible to maintain the best possible dimming performance.

The refresh rate settings are only active as long as the value on the 'Control channel' is hold. The value should be stored as a preset or as the default value for the 'Control channel' in the control device.

Be aware that the 'Control channel' is also used for fixture reset functions and DMX capture for the internal sequence editor.

When adjusting a custom value, you want to choose a frequency high enough to avoid flickering and/or horizontal banding (rolling shutter), but low enough to maintain a good dimming performance.

Since there are differences between camera models, exposure settings etc., the optimal refresh rate settings will differ. In order to achieve the best result, adjust the refresh rate through a preview monitor with a feed from the cameras.

Control panel menus

Level 1	Level 2	Level 3	Level 4	Info
DMX MODE	STANDARD			
	EXTENDED			
INFO	GENRAL INFO	PRODUCT: SN: RDM LABEL RDM ID		
	SOFTWARE VERSION	MAIN: SMPS: PAN: TILT: GOBO: ZOOM:		

Level 1	Level 2	Level 3	Level 4	Info
INFO (continued)	TIMERS	RED GREEN BLUE RUNNING HOURS	D: H: D: H: D: H: D: H:	
	DMX VIEW	001 - ↓ 507 -		
	TEMPERATURES	LED SMPS PAN: GOBO: BASE: HUMIDITY	R: G: B: TILT: FOCUS: HEAD: B: H:	
	SENSORS			

Level 1	Level 2	Level 3	Level 4	Info
INFO (continued)	FANS	LED FAN 1: LED FAN 2: HEAD: BASE:	rpm rpm rpm rpm	
	LOG	FIRMWARE: BUILD: BUILD: UPTIME:	D: H: M: S:	
	ERRORS	SMPS PAN TILT GOBO ZOOM		ERROR DETAILS

Level 1	Level 2	Level 3	Level 4	Info
SETTINGS	WIRELESS DMX	LOG OFF		
		STATUS	SIGNAL STRENGHT % CRMX PAIRD: RDM ACTIVE: DMX ACTIVE: CRMX RATE Hz	
		ENABLE/DISABLE		
		CRMX → DMX		

Level 1	Level 2	Level 3	Level 4	Info
SETTINGS (continued)	DIMMING CURVE	LINEAR () GAMMA CORRECTED (X)		
	INVERT PAN ()			
	INVERT TILT ()			
	SWAP PAN TILT ()			
	FLIP DISPLAY ()			
	DISPLAY OFF ()			
	FAN MODE	STANDARD SILENT MAX POWER ALWAYS 100%		

Level 1	Level 2	Level 3	Level 4	Info
SETTINGS (continued)	CALIBRATION	PAN HOME	CALIBRATION → XXXXX PAN POS XXXX - REV. X.XX	
		TILT HOME	CALIBRATION → XXXXX PAN POS XXXX - REV. X.XX	
		GOBO SELECT	CALIBRATION → XXXXX	
		EFFECT WHEEL	CALIBRATION → XXXXX	

Level 1	Level 2	Level 3	Level 4	Info
SETTINGS (continued)	CALIBRATION (continued)	FROST	CALIBRATION → XXXXX	
		PRISM	CALIBRATION → XXXXX	
		IRS	CALIBRATION → XXXXX	
		ZOOM	CALIBRATION → XXXXX	
		FOCUS	CALIBRATION → XXXXX	
	SERVICE PIN			
	SERVICE MENU	FIXTURE TYPE		
		DEBUG		

Level 1	Level 2	Level 3	Level 4	Info
SETTINGS (continued)	FACTORY DEFAULT	FACTORY DEFAULT SET		
TEST	OFF			
	AUTOMATED TEST			
	LED TEST	TESTING RED 2		
		TESTING RED 1		
		TESTING BLUE 2		
		TESTING BLUE 1		
		TESTING YELLOW		
		TESTING GREEN		
DISPLAY TEST				

Level 1	Level 2	Level 3	Level 4	Info	
RESET	PAN TILT			See note 1	
	EFFECT MODULE				
	ZOOM FOCUS MODULE				
	ALL				
MANUAL	EDITOR	SCENE	1 → 24		
		WAIT TIME	Seconds	0 → 4000	
		FADE TIME	Seconds	0 → 4000	
		COPY SCENE			
		PASTE SCENE			
		CLEAR SCENE			
		SHUTTER			
		DIMMER			

Level 1	Level 2	Level 3	Level 4	Info
MANUAL (continued)	EDITOR (continued)	RED		
		GREEN		
		BLUE		
		CTC		
		PAN		Center = 32767
		TILT		Center = 32767
		GOBO 1		Select
		GOBO 1 ROT		Rotation
		BLADE 1 ANG		Angle of blade 1
		BLADE 2 IN		
		BLADE 2 ANG		Angle of blade 2
		BLADE 2 IN		
		BLADE 3 ANG		Angle of blade 3

Level 1	Level 2	Level 3	Level 4	Info
MANUAL (continued)	EDITOR (continued)	BLADE 3 IN		
		BLADE 4 ANG		Angle of blade 4
		BLADE 4 IN		
		BLADE ANG		Module rotation
		EFFECT WHEEL		
		IRIS		
		PRISM		
		FROST		
		ZOOM		
		FOCUS		
	RUN PROGRAM			
	STOP PROGRAM			

Level 1	Level 2	Level 3	Level 4	Info	
	RUN ON POWER ON	Enable by pressing OK Disable by pressing OK		() / (X)	
	CAPTURE DMX	SCENE	1 → 24		
		WAIT TIME	Seconds	0 → 4000	
		FADE TIME	Seconds	0 → 4000	
		CAPTURE DMX			Capture DMX values of all channels from DMX input

1. If the G-Profile is subjected to extreme exposure, the fixture might not reset correctly. If this happens, the fixture will automatically heat up the gobo bearings at maximum light output for approx. five minutes and attempt to reset the fixture again. Should this not resolve the issue, disconnect the fixture from power, and power it back on again to repeat the heat-up procedure. Should this not solve the issue, contact your local SGM distributor or SGM Technical Support. See <http://sgmlight.com/service-aftersales/> for more details.

Gobo replacement

Identification of gobo wheel

Gobo Wheel

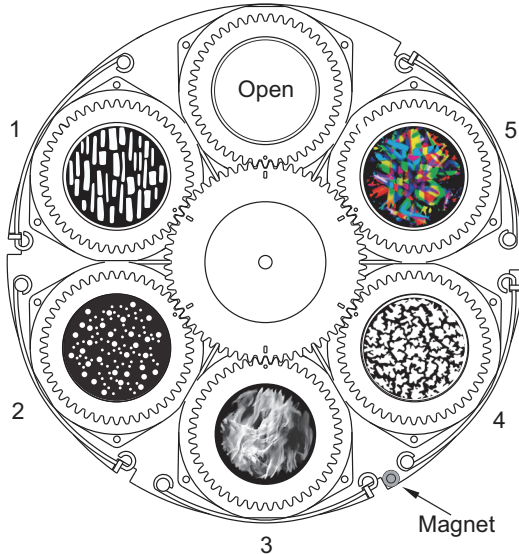

No.	Description	Part No.
Open	Open gobo	37000001
1	Breakup bricks	37005006
2	Dots	37005003
3	Fire up close	37005001
4	Spiral leaf	37005010
5	Kaleidoscope gems	37002001

Replacing rotating gobo

To replace a gobo:

- Disconnect the fixture from power and allow to cool.
- Position the head and apply the tilt lock.
- Remove the rear head cover located on the same side as the pan lock (A). See figure below.
- Remove the gobo wheel cover for access to the gobo wheel.
- Turn the gobo wheel until the gobo you want to replace is accessible.
- Unhook the end of the spring and turn it upwards. Pull the gobo holder out of the gobo wheel.

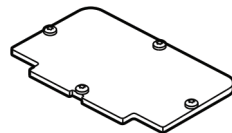
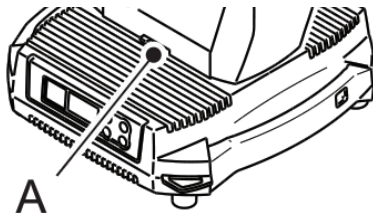
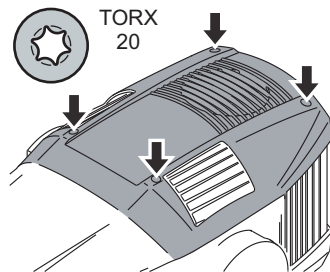

Gobo Wheel Cover

How to replace a gobo in a gobo holder

- Place gobo with silver side towards the light source.
- Align index markers on the gobo and the gobo holder as shown below.
- Insert the gobo holder and align it with the index marker on the gobo wheel as shown below. If necessary, continue replacing gobos one by one as described above. If no further service is necessary, reinstall the gobo wheel cover. To maintain the fixture's IP65 rating, it is important to fasten the gobo covers to 1 Nm.

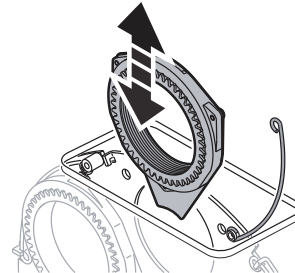
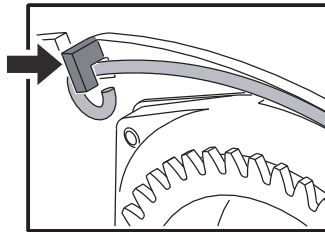
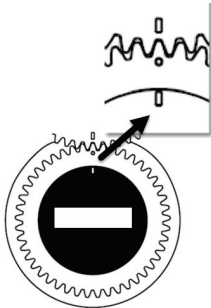
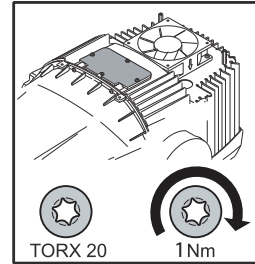

Maintenance

When cleaning the fixture, do not use any product that contains abrasives or solvents that can damage plastic or painted surfaces. Use a clean cloth with water and a standard household cleaner.

To maintain adequate cooling, fans must be cleaned periodically.

Upgrading the firmware

The firmware installed on the fixture can be identified using the “Info→Software version” menu. We recommend that you keep your fixture’s firmware up-to-date. Visit <http://www.sgmlight.com> to download the latest firmware.

To perform firmware updates, you need a Windows-based personal computer and a SGM USB 5-Pin-XLR upload cable (available from your SGM distributor).

Cleaning

To maintain optimal performance, regular cleaning is essential. Cleaning schedules will vary greatly depending on the operating environment, and the installation should therefore be checked at frequent intervals within the first few weeks of operation to see whether cleaning is necessary. This procedure will allow you to assess cleaning requirements in your particular situation. If in doubt, consult your SGM dealer for a suitable maintenance schedule.

Setting the OLED display saver

By default the OLED display dims down after a short period when the control panel is not in use, but it can also be set to turn off completely. Pressing any key will always turn on the display or restore it to normal brightness. To change the display saver, use the “Settings→Display Off” menu.

NOTE: To avoid the risk of display deterioration caused by long term use in permanent installations, it is recommended to use the “Settings→Display Off” setting.

DMX protocols

31 Channel Mode (Standard)									
Channel	Name	DMX Value		DMX Percentage		Description	Info	Default DMX Value	Fader Type
1	Shutter	0	7	0,0%	2,7%	Closed		10 (3,9%)	Snap
		8	15	3,1%	5,9%	Open 1 (‘Pre-heat’ enabled)	See note 1		
		16	151	6,3%	59,2%	Strobe	Slow > Fast		
		152	175	59,6%	68,6%	Pulse - Open	Slow > Fast		
		176	199	69,0%	78,0%	Pulse - Close	Slow > Fast		
		200	244	78,4%	95,7%	Strobe - Random	Slow > Fast		
		245	255	96,1%	100,0%	Open 2 (‘Pre-heat’ disabled)	See note 2		
2	Intensity	0	255	0,0%	100,0%	No light > Maximum light		0 (0%)	Fade

Channel	Name	DMX Value	DMX Percentage	Description	Info	Default DMX Value	Fader Type
3	Red	0 255	0,0% 100,0%	No RED > Maximum RED		0 (0%)	Fade
4	Green	0 255	0,0% 100,0%	No GREEN > Maximum GREEN		0 (0%)	Fade
5	Blue	0 255	0,0% 100,0%	No BLUE > Maximum BLUE		0 (0%)	Fade
6	CTC	0 4	0,0% 1,6%	No CTC		182 (71,3%)	Fade
		5 5	2,0% 2,0%	≈ 2000° K			
		15 15	5,9% 5,9%	≈ 2200° K (High Pressure Sodium Lamp)			
		40 40	15,7% 15,7%	≈ 2700° K (Incandescent Lamp)			
		54 54	21,2% 21,2%	≈ 3000° K (Halogen / Tungsten Lamp)			

Channel	Name	DMX Value	DMX Percentage	Description	Info	Default DMX Value	Fader Type	
6	CTC	65	65	25,5%	25,5%	≈ 3200° K (Warm Metal Halide Lamp)	182 (71,3%)	Fade
		105	105	41,2%	41,2%	≈ 4000° K (Clear Metal Halide Lamp)		
		115	115	45,1%	45,1%	≈ 4200° K (Cool White Fluorescent Lamp)		
		177	177	69,4%	69,4%	≈ 5500° K (Daylight Metal Halide Lamp)		
		216	216	84,7%	84,7%	≈ 6300° K		
		238	238	93,3%	93,3%	≈ 8000° K		
		255	255	100,0%	100,0%	≈ 10,000° K		

Channel	Name	DMX Value	DMX Percentage	Description	Info	Default DMX Value	Fader Type
7 8	Pan	0 65535	0,0% 100,0%	-270° to 270°	-270° = Front Lens @ Mains Power Input (Tilt=0)	32767 (50%)	Fade
9 10	Tilt	0 65535	0,0% 100,0%	-120° to 120°	-120° = Front Lens @ Base Front (Pan=32767)	32767 (50%)	Fade
11	Gobo Wheel 1 (closest to light source)	0 20	0,0% 7,8%	Open		0 (%)	Snap
		21 41	8,2% 16,1%	Gobo 1 - Position 1			
		42 62	16,5% 24,3%	Gobo 1 - Position 2			
		63 83	24,7% 32,5%	Gobo 1 - Position 3			
		84 104	32,9% 40,8%	Gobo 1 - Position 4			
		105 127	41,2% 49,8%	Gobo 1 - Position 5			

Channel	Name	DMX Value	DMX Percentage	Description	Info	Default DMX Value	Fader Type		
11	Gobo Wheel 1 (closest to light source)	128	191	50,2%	74,9%	Gobo Wheel Continuous Rotation CW	Fast > Slow	0 (0%)	Snap
		192	192	75,3%	75,3%	No Rotation			
		193	255	75,7%	100,0%	Gobo Wheel Continuous Rotation CCW	Slow > Fast		
12 13	Gobo Wheel 1 Indexing Rotation Shake	0	32767	0,0%	50,0%	Gobo Index		0 (0%)	Fade
		32768	32799	50,0%	50,0%	No Effect			
		32800	46418	50,0%	70,8%	Gobo Continuous Rotation CW	Fast > Slow		
		46419	46919	70,8%	71,6%	No Rotation			
		46920	60538	71,6%	92,4%	Gobo Continuous Rotation CW	Slow > Fast		
		60539	65535	92,4%	100,0%	Gobo Shake	Slow >Fast		

Channel	Name	DMX Value		DMX Percentage		Description	Info	Default DMX Value	Fader Type
14	Blade 1 In	0	255	0,0%	100,0%	Blade 1 In	Out -> In	0 (0%)	Fade
15	Blade 1 Angle	0	255	0,0%	100,0%	Blade 1 Angle	-30° -> +30°	128 (50%)	Fade
16	Blade 2 In	0	255	0,0%	100,0%	Blade 2 In	Out -> In	0 (0%)	Fade
17	Blade 2 Angle	0	255	0,0%	100,0%	Blade 2 Angle	-30° -> +30°	128 (50%)	Fade
18	Blade 3 In	0	255	0,0%	100,0%	Blade 3 In	Out -> In	0 (0%)	Fade
19	Blade 3 Angle	0	255	0,0%	100,0%	Blade 3 Angle	-30° -> +30°	128 (50%)	Fade
20	Blade 4 In	0	255	0,0%	100,0%	Blade 4 In	Out -> In	0 (0%)	Fade
21	Blade 4 Angle	0	255	0,0%	100,0%	Blade 4 Angle	-30° -> +30°	128 (50%)	Fade
22	Blade Assembly Rot.	0	255	0,0%	100,0%	Blade Assembly Rotate	-45° -> +45°	128 (50%)	Fade

Channel	Name	DMX Value	DMX Percentage	Description	Info	Default DMX Value	Fader Type		
23 24	Effect Wheel	0	511	0,0%	0,8%	Open	0 (0%)	Fade	
		512	2559	0,8%	3,9%	Inserted not indexed			
		2560	32767	3,9%	50,0%	Indexed			
		32768	46402	50,0%	70,8%	Continuous rotation CW			Fast > Slow
		46403	46903	70,8%	71,6%	Stop			
		46904	60538	71,6%	92,4%	Continuous rotation CCW			Slow > Fast
		60539	65535	92,4%	100,0%	Reserved (calibration position)			
25	Iris	0	200	0,0%	78,4%	Open > Close	0 (0%)	Fade	
		201	205	78,8%	80,4%	Effect - "Open fast / Close slow"			

Channel	Name	DMX Value	DMX Percentage	Description	Info	Default DMX Value	Fader Type		
25	Iris	206	210	80,8%	82,4%	Effect - "Open slow / Close fast"	0 (0%)	Fade	
		211	215	82,7%	84,3%	Effect - "Open / Close"			
		216	255	84,7%	100,0%	Effect - "Random Close / Open"			Slow > Fast
26	Prism	0	4	0,0%	1,6%	Open	0 (0%)	Fade	
		5	129	2,0%	50,6%	Continuous Rotation CW			Fast > Slow
		130	130	51,0%	51,0%	No Rotation			
		131	255	51,4%	100,0%	Continuous Rotation CCW			Slow > Fast
27	Frost	0	5	0,0%	2,0%	Open	0 (0%)	Fade	
		6	255	2,4%	100,0%	No Frost > Maximum Frost			

Channel	Name	DMX Value	DMX Percentage	Description	Info	Default DMX Value	Fader Type
28	Zoom	0 255	0,0% 100,0%	Wide > Narrow		0 (0%)	Fade
29	Focus	0 255	0,0% 100,0%	Far > Near		0 (0%)	Fade
30	Effect Channel	0 4	0,0% 1,6%	No Effect		0 (0%)	Snap
		5 15	2,0% 5,9%	Reserved (No Effect)			
		16 26	6,3% 10,2%	Reserved (No Effect)			
		27 32	10,6% 12,5%	Shutter Black = RED			
		33 38	12,9% 14,9%	Shutter Black = GREEN			
		39 44	15,3% 17,3%	Shutter Black = BLUE			
		45 50	17,6% 19,6%	Shutter Black = WHITE			
		51 56	20,0% 22,0%	Shutter Black = Magenta			
		57 62	22,4% 24,3%	Shutter Black = Yellow			
		63 68	24,7% 26,7%	Shutter Black = Cyan			

Channel	Name	DMX Value	DMX Percentage	Description	Info	Default DMX Value	Fader Type
30	Effect Channel	69 255	27,1% 100,0%	Reserved (No Effect)		0 (0%)	Snap
31	Control Channel	0 4	0,0% 1,6%	No Function		0 (0%)	Snap
		5 9	2,0% 3,5%	Full Reset	Hold 3 seconds		
		10 14	3,9% 5,5%	Pan Reset	Hold 3 seconds		
		15 19	5,9% 7,5%	Tilt Reset	Hold 3 seconds		
		20 24	7,8% 9,4%	Gobo Reset	Hold 3 seconds		
		25 29	9,8% 11,4%	Zoom Reset	Hold 3 seconds		
		30 34	11,8% 13,3%	Sleep Mode	See note 3		

Channel	Name	DMX Value	DMX Percentage	Description	Info	Default DMX Value	Fader Type		
31	Control Channel	35	39	13,7%	15,3%	Display Off	Hold 3 seconds	0 (0%)	Snap
		40	44	15,7%	17,3%	Display On	Hold 3 seconds		
		45	115	17,6%	100,0%	LED Frequency (100 kHz - 1,41kHz)	See note 4		
		116	119	45,5%	46,7%	Capture Scene 1	See note 5		
		120	123	47,1%	48,2%	Capture Scene 2			
		124	129	48,6%	49,8%	Capture Scene 3			
		128	131	50,2%	51,4%	Capture Scene 4			
		132	135	51,8%	52,9%	Capture Scene 5			
		136	139	53,3%	54,5%	Capture Scene 6			
140	143	54,9%	56,1%	Capture Scene 7					

Channel	Name	DMX Value	DMX Percentage	Description	Info	Default DMX Value	Fader Type		
31	Control Channel	144	147	56,5%	57,6%	Capture Scene 8	See note 5	0 (0%)	Snap
		148	151	58,0%	59,2%	Capture Scene 9			
		152	155	59,6%	60,8%	Capture Scene 10			
		156	159	61,2%	62,4%	Capture Scene 11			
		160	163	62,7%	63,9%	Capture Scene 12			
		164	167	64,3%	65,5%	Capture Scene 13			
		168	171	65,9%	67,1%	Capture Scene 14			
		172	175	67,5%	68,6%	Capture Scene 15			
		176	179	69,0%	70,2%	Capture Scene 16			
		180	183	70,6%	71,8%	Capture Scene 17			
		184	187	72,2%	73,3%	Capture Scene 18			
		188	191	73,7%	74,9%	Capture Scene 19			

Channel	Name	DMX Value	DMX Percentage	Description	Info	Default DMX Value	Fader Type		
31	Control Channel	192	195	75,3%	76,5%	Capture Scene 20	See note 5	0 (0%)	Snap
		196	199	76,9%	78,0%	Capture Scene 21			
		200	203	78,4%	79,6%	Capture Scene 22			
		204	207	80,0%	81,2%	Capture Scene 23			
		208	211	81,6%	82,7%	Capture Scene 24			
		212	255	83,1%	100,0%	Reserved (No Function)			

1. 'Pre-heat' enabled = ready for instant operation.
2. 'Pre-heat' disabled = to perform a complete blackout, use 'Open 2'. This will take 400 milliseconds to exit.
3. All other channels must be zero and this has to be held for 30 sec. (fixture will wake up on a full reset).
4. Set LED frequency refresh rate, see separate documentation for frequencies, see manual for details value must be hold to keep setting (default value 1,41 kHz)
5. Hold for 3 sec to capture scenes for internal program (stand-alone operation) see manual for details.

46 Channel Mode (Standard)

Channel	Name	DMX Value	DMX Percentage	Description	Info	Default DMX Value	Fader Type		
1	Shutter	0	7	0,0%	2,7%	Closed	10 (3,9%)	Snap	
		8	15	3,1%	5,9%	Open 1 (‘Pre-heat’ enabled)			See note 1
		16	151	6,3%	59,2%	Strobe			Slow > Fast
		152	175	59,6%	68,6%	Pulse - Open			Slow > Fast
		176	199	69,0%	78,0%	Pulse - Close			Slow > Fast
		200	244	78,4%	95,7%	Strobe - Random			Slow > Fast
		245	255	96,1%	100,0%	Open 2 (‘Pre-heat’ disabled)			See note 2
2 3	Intensity	0	255	0,0%	100,0%	No light > Maximum light	0 (0%)	Fade	

Channel	Name	DMX Value	DMX Percentage	Description	Info	Default DMX Value	Fader Type
4 5	Red	0 255	0,0% 100,0%	No RED > Maximum RED		0 (0%)	Fade
6 7	Green	0 255	0,0% 100,0%	No GREEN > Maximum GREEN		0 (0%)	Fade
8 9	Blue	0 255	0,0% 100,0%	No BLUE > Maximum BLUE		0 (0%)	Fade
10	CTC	0 4	0,0% 1,6%	No CTC		182 (71,3%)	Fade
		5 5	2,0% 2,0%	≈ 2000° K			
		15 15	5,9% 5,9%	≈ 2200° K (High Pressure Sodium Lamp)			
		40 40	15,7% 15,7%	≈ 2700° K (Incandescent Lamp)			
		54 54	21,2% 21,2%	≈ 3000° K (Halogen / Tungsten Lamp)			

Channel	Name	DMX Value	DMX Percentage	Description	Info	Default DMX Value	Fader Type	
10	CTC	65	65	25,5%	25,5%	≈ 3200° K (Warm Metal Halide Lamp)	182 (71,3%)	Fade
		105	105	41,2%	41,2%	≈ 4000° K (Clear Metal Halide Lamp)		
		115	115	45,1%	45,1%	≈ 4200° K (Cool White Fluorescent Lamp)		
		177	177	69,4%	69,4%	≈ 5500° K (Daylight Metal Halide Lamp)		
		216	216	84,7%	84,7%	≈ 6300° K		
		238	238	93,3%	93,3%	≈ 8000° K		
		255	255	100,0%	100,0%	≈ 10,000° K		

Channel	Name	DMX Value	DMX Percentage	Description	Info	Default DMX Value	Fader Type
11 12	Pan	0 65535	0,0% 100,0%	-270° to 270°	-270° = Front Lens @ Mains Power Input (Tilt=0)	32767 (50%)	Fade
13 14	Tilt	0 65535	0,0% 100,0%	-120° to 120°	-120° = Front Lens @ Base Front (Pan=32767)	32767 (50%)	Fade
15	Gobo Wheel 1 (closest to light source)	0 20	0,0% 7,8%	Open		0 (%)	Snap
		21 41	8,2% 16,1%	Gobo 1 - Position 1			
		42 62	16,5% 24,3%	Gobo 1 - Position 2			
		63 83	24,7% 32,5%	Gobo 1 - Position 3			
		84 104	32,9% 40,8%	Gobo 1 - Position 4			
		105 127	41,2% 49,8%	Gobo 1 - Position 5			

Channel	Name	DMX Value	DMX Percentage	Description	Info	Default DMX Value	Fader Type		
15	Gobo Wheel 1 (closest to light source)	128	191	50,2%	74,9%	Gobo Wheel Continuous Rotation CW	Fast > Slow	0 (0%)	Snap
		192	192	75,3%	75,3%	No Rotation			
		193	255	75,7%	100,0%	Gobo Wheel Continuous Rotation CCW	Slow > Fast		
16 17	Gobo Wheel 1 Indexing Rotation Shake	0	32767	0,0%	50,0%	Gobo Index		0 (0%)	Fade
		32768	32799	50,0%	50,0%	No Effect			
		32800	46418	50,0%	70,8%	Gobo Continuous Rotation CW	Fast > Slow		
		46419	46919	70,8%	71,6%	No Rotation			
		46920	60538	71,6%	92,4%	Gobo Continuous Rotation CW	Slow > Fast		
		60539	65535	92,4%	100,0%	Gobo Shake	Slow >Fast		

Channel	Name	DMX Value	DMX Percentage	Description	Info	Default DMX Value	Fader Type
18 19	Blade 1 In	0 255	0,0% 100,0%	Blade 1 In	Out -> In	0 (0%)	Fade
20 21	Blade 1 Angle	0 255	0,0% 100,0%	Blade 1 Angle	-30° -> +30°	128 (50%)	Fade
22 23	Blade 2 In	0 255	0,0% 100,0%	Blade 2 In	Out -> In	0 (0%)	Fade
24 25	Blade 2 Angle	0 255	0,0% 100,0%	Blade 2 Angle	-30° -> +30°	128 (50%)	Fade
26 27	Blade 3 In	0 255	0,0% 100,0%	Blade 3 In	Out -> In	0 (0%)	Fade
28 29	Blade 3 Angle	0 255	0,0% 100,0%	Blade 3 Angle	-30° -> +30°	128 (50%)	Fade
30 31	Blade 4 In	0 255	0,0% 100,0%	Blade 4 In	Out -> In	0 (0%)	Fade

Channel	Name	DMX Value	DMX Percentage	Description	Info	Default DMX Value	Fader Type
32 33	Blade 4 Angle	0 255	0,0% 100,0%	Blade 4 Angle	-30° -> +30°	128 (50%)	Fade
34 35	Blade Assembly Rot.	0 255	0,0% 100,0%	Blade Assembly Rotate	-45° -> +45°	128 (50%)	Fade
36 37	Effect Wheel	0 511	0,0% 0,8%	Open		0 (0%)	Fade
		512 2559	0,8% 3,9%	Inserted not indexed			
		2560 32767	3,9% 50,0%	Indexed			
		32768 46402	50,0% 70,8%	Continuous rotation CW	Fast > Slow		
		46403 46903	70,8% 71,6%	Stop			
		46904 60538	71,6% 92,4%	Continuous rotation CCW	Slow > Fast		
		60539 65535	92,4% 100,0%	Reserved (calibration position)			

Channel	Name	DMX Value	DMX Percentage	Description	Info	Default DMX Value	Fader Type		
38	Iris	0	200	0,0%	78,4%	Open > Close	0 (0%)	Fade	
		201	205	78,8%	80,4%	Effect - "Open fast / Close slow"			
		206	210	80,8%	82,4%	Effect - "Open slow / Close fast"			
		211	215	82,7%	84,3%	Effect - "Open / Close"			
		216	255	84,7%	100,0%	Effect - "Random Close / Open"			Slow > Fast
39	Prism	0	4	0,0%	1,6%	Open	0 (0%)	Fade	
		5	129	2,0%	50,6%	Continuous Rotation CW			Fast > Slow
		130	130	51,0%	51,0%	No Rotation			
		131	255	51,4%	100,0%	Continuous Rotation CCW			Slow > Fast

Channel	Name	DMX Value	DMX Percentage	Description	Info	Default DMX Value	Fader Type	
40	Frost	0	5	0,0%	2,0%	0 (0%)	Fade	
		6	255	2,4%	100,0%			No Frost > Maximum Frost
41 42	Zoom	0	255	0,0%	100,0%	0 (0%)	Fade	
43 44	Focus	0	255	0,0%	100,0%	0 (0%)	Fade	
45	Effect Channel	0	4	0,0%	1,6%	0 (0%)	Snap	
		5	15	2,0%	5,9%			Reserved (No Effect)
		16	26	6,3%	10,2%			Reserved (No Effect)
		27	32	10,6%	12,5%			Shutter Black = RED
		33	38	12,9%	14,9%			Shutter Black = GREEN

Channel	Name	DMX Value	DMX Percentage	Description	Info	Default DMX Value	Fader Type		
45	Effect Channel	39	44	15,3%	17,3%	Shutter Black = BLUE	0 (0%)	Snap	
		45	50	17,6%	19,6%	Shutter Black = WHITE			
		51	56	20,0%	22,0%	Shutter Black = Magenta			
		57	62	22,4%	24,3%	Shutter Black = Yellow			
		63	68	24,7%	26,7%	Shutter Black = Cyan			
		69	255	27,1%	100,0%	Reserved (No Effect)			
46	Control Channel	0	4	0,0%	1,6%	No Function	0 (0%)	Snap	
		5	9	2,0%	3,5%	Full Reset			Hold 3 seconds
		10	14	3,9%	5,5%	Pan Reset			Hold 3 seconds
		15	19	5,9%	7,5%	Tilt Reset			Hold 3 seconds

Channel	Name	DMX Value	DMX Percentage	Description	Info	Default DMX Value	Fader Type		
46	Control Channel	20	24	7,8%	9,4%	Gobo Reset	Hold 3 seconds	0 (0%)	Snap
		25	29	9,8%	11,4%	Zoom Reset	Hold 3 seconds		
		30	34	11,8%	13,3%	Sleep Mode	See note 3		
		35	39	13,7%	15,3%	Display Off	Hold 3 seconds		
		40	44	15,7%	17,3%	Display On	Hold 3 seconds		
		45	115	17,6%	100,0%	LED Frequency (100 kHz - 1,41kHz)	See note 4		
		116	119	45,5%	46,7%	Capture Scene 1	See note 5		
		120	123	47,1%	48,2%	Capture Scene 2			
		124	129	48,6%	49,8%	Capture Scene 3			

Channel	Name	DMX Value	DMX Percentage	Description	Info	Default DMX Value	Fader Type		
46	Control Channel	128	131	50,2%	51,4%	Capture Scene 4	See note 5	0 (0%)	Snap
		132	135	51,8%	52,9%	Capture Scene 5			
		136	139	53,3%	54,5%	Capture Scene 6			
		140	143	54,9%	56,1%	Capture Scene 7			
		144	147	56,5%	57,6%	Capture Scene 8			
		148	151	58,0%	59,2%	Capture Scene 9			
		152	155	59,6%	60,8%	Capture Scene 10			
		156	159	61,2%	62,4%	Capture Scene 11			
		160	163	62,7%	63,9%	Capture Scene 12			
		164	167	64,3%	65,5%	Capture Scene 13			
		168	171	65,9%	67,1%	Capture Scene 14			
		172	175	67,5%	68,6%	Capture Scene 15			

Channel	Name	DMX Value	DMX Percentage	Description	Info	Default DMX Value	Fader Type	
46	Control Channel	176	179	69,0%	70,2%	Capture Scene 16	See note 5	Snap
		180	183	70,6%	71,8%	Capture Scene 17		
		184	187	72,2%	73,3%	Capture Scene 18		
		188	191	73,7%	74,9%	Capture Scene 19		
		192	195	75,3%	76,5%	Capture Scene 20		
		196	199	76,9%	78,0%	Capture Scene 21		
		200	203	78,4%	79,6%	Capture Scene 22		
		204	207	80,0%	81,2%	Capture Scene 23		
		208	211	81,6%	82,7%	Capture Scene 24		
		212	255	83,1%	100,0%	Reserved (No Function)		

1. 'Pre-heat' enabled = ready for instant operation.
2. 'Pre-heat' disabled = to perform a complete blackout, use 'Open 2'. This will take 400 milliseconds to exit.
3. All other channels must be zero and this has to be held for 30 sec. (fixture will wake up on a full reset).
4. Set LED frequency refresh rate, see separate documentation for frequencies, see manual for details value must be hold to keep setting (default value 1,41 kHz)
5. Hold for 3 sec to capture scenes for internal program (stand-alone operation) see manual for details.

Full Color Calibration and Color Temperature Correction

31 and 46 Channel Mode: Features full color calibration when you mix 2 or 3 colors to ensure uniform color between products. Adjusting 1 color does not activate full color calibration.

31 and 46 Channel Mode: Features full color temperature correction when channel 6 (in 31 channel mode) or channel 10 (in 46 channel mode) are at DMX value 5 or higher. When the value is below 5, the fixture runs in RAW mode.

Effects

Four individually controllable framing blades

The four individually controllable framing blades are each adjustable ± 30 degrees while the module is rotatable through ± 45 degrees. The framing blades allows the G-Profile to perform beam-shaping images and projections (see examples below) and “DMX protocols” on page 38 for more details.

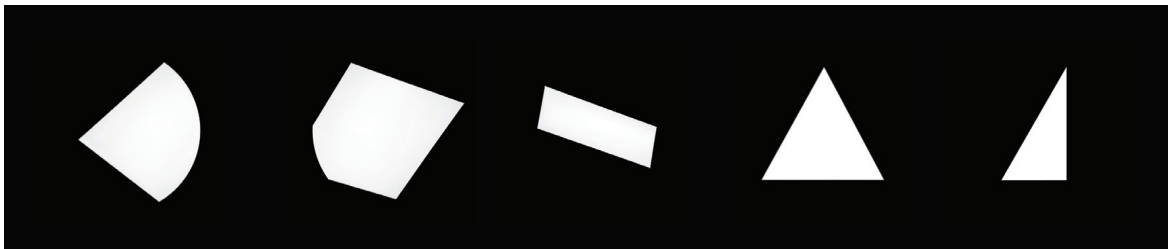

Independent rotating gobo wheel

The independent rotating gobo wheel has five slots plus one open position to control the shape of emitted light. The gobo is indexable with bi-directional rotation. The standard gobo includes both breakup patterns, geometric gobos and full colored gobos.

Combination of framing techniques and rotating gobos

The G-Profile provides the option of combining framing techniques with 5 rotating gobos and opens for gobo animation and interaction when framing is used.

Effect wheel

The G-Profile has an effect wheel for generating optical effect. The effect wheel features continuous rotation with variable speed and direction.

High-precision pan and tilt

The G-Profile has a 16-bit pan and tilt control, with a 540° pan and 270° tilt movement with feedback.

Ultra high-speed strobe effect

The ultra high-speed strobe effect (1-50 Hz) introduces instant color control and the possibility to strobe between two or more colors at any speed by. Random strobe and pulse effects can be generated with variable speed.

Prism

4-facet rotating prism.

Frost

The soft high-quality frost filter is variable from 0% to 100%.

Fixtures and accessories

Included items

Two Omega brackets with 1/4-turn fasteners
2 m power cable with Neutrik TRUE1 power connector
User manual

Ordering information

G-Profile Moving Head in cardboard box	Order no: 80021010
G-Profile Moving Head in flight case (1 fixture).....	Order no: 80021011
SGM USB uploader cable	Order no: 83062011
2 m power cable with Neutrik TRUE1 power connector	Order no: 07860040
Flight case (1 fixture).....	Order no: 82051003

APPROVALS AND CERTIFICATIONS

Conforms to	2004/108/EC: EMC Directive
Conforms to	2006/95/EC: Low Voltage Directive
Conforms to	2011/65/EU: RoHS2 Directive
Conforms to	UL Std.1573
Certified to	CSA E60598-1:02, Ed: 2
Certified to	CSA-E598-2-17-98, Ed: 1



The information in this document is subject to change without notice

User's notes



SGM Light A/S · Sommervej 23 · 8210 Aarhus V · Denmark
Tel +45 70 20 74 00 · info@sgmlight.com · www.sgmlight.com